

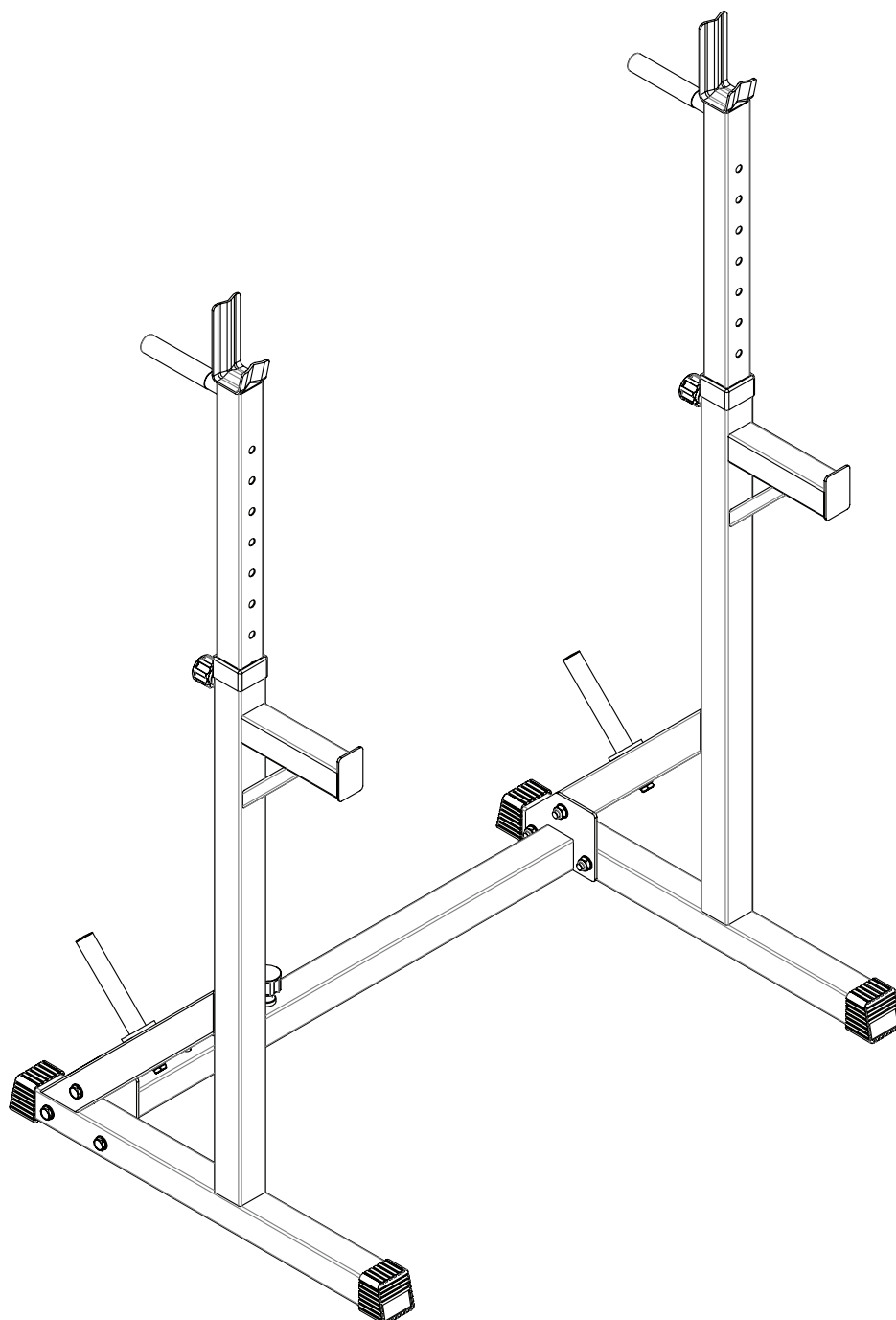

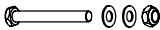





virtuafit

Adjustable Squat Rack

Návod k obsluze



ČÍSLO	POPIS	NÁKRES	POČET
1	Šroub, matice, podložka M10 X 70		6
2	Šroub, podložka M10 X 20		2
3	Aretační šroub		3
4	Pouzdro 50-45		3
5	Krytka nožiček 50*50		4
6	Madlo Ø25		2
7	Ø25 Tube Plug		2
8	Nárazová podložka Ø25 - Ø50		2
9	Gumová podložka		2

1. KROK

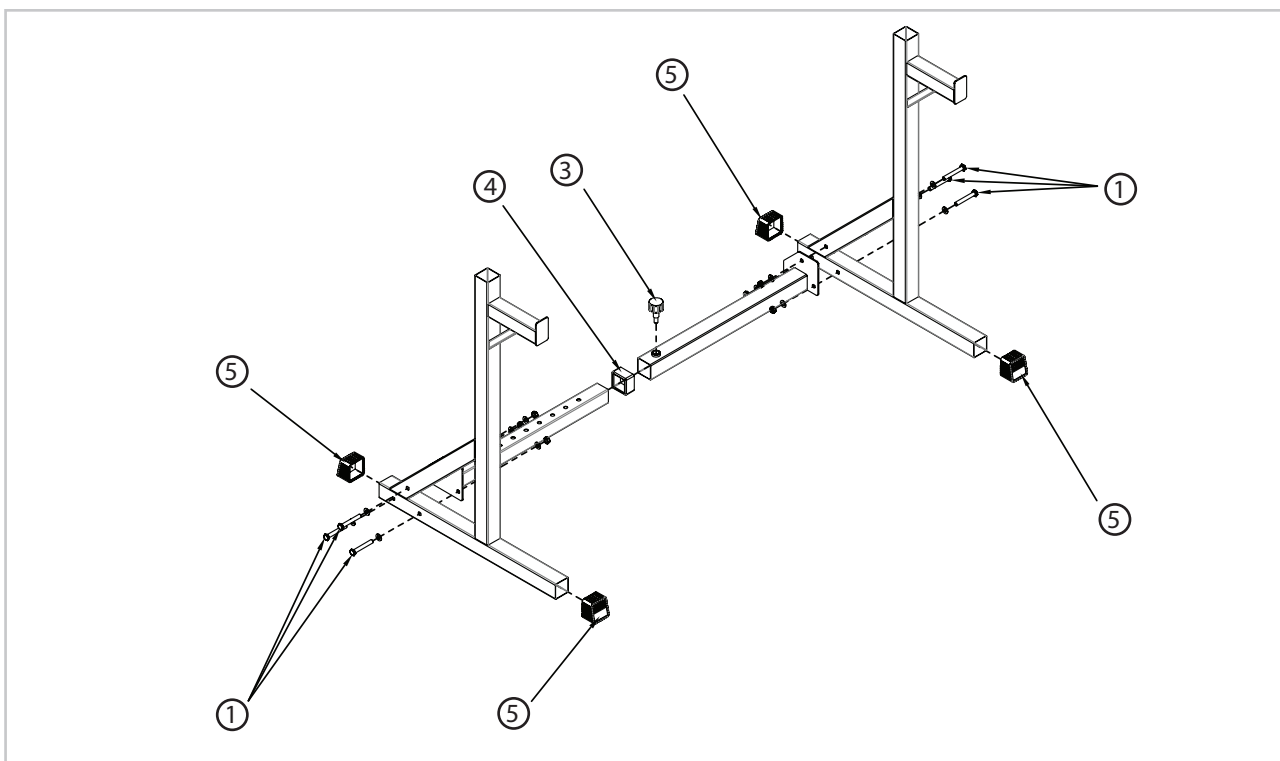

2. KROK

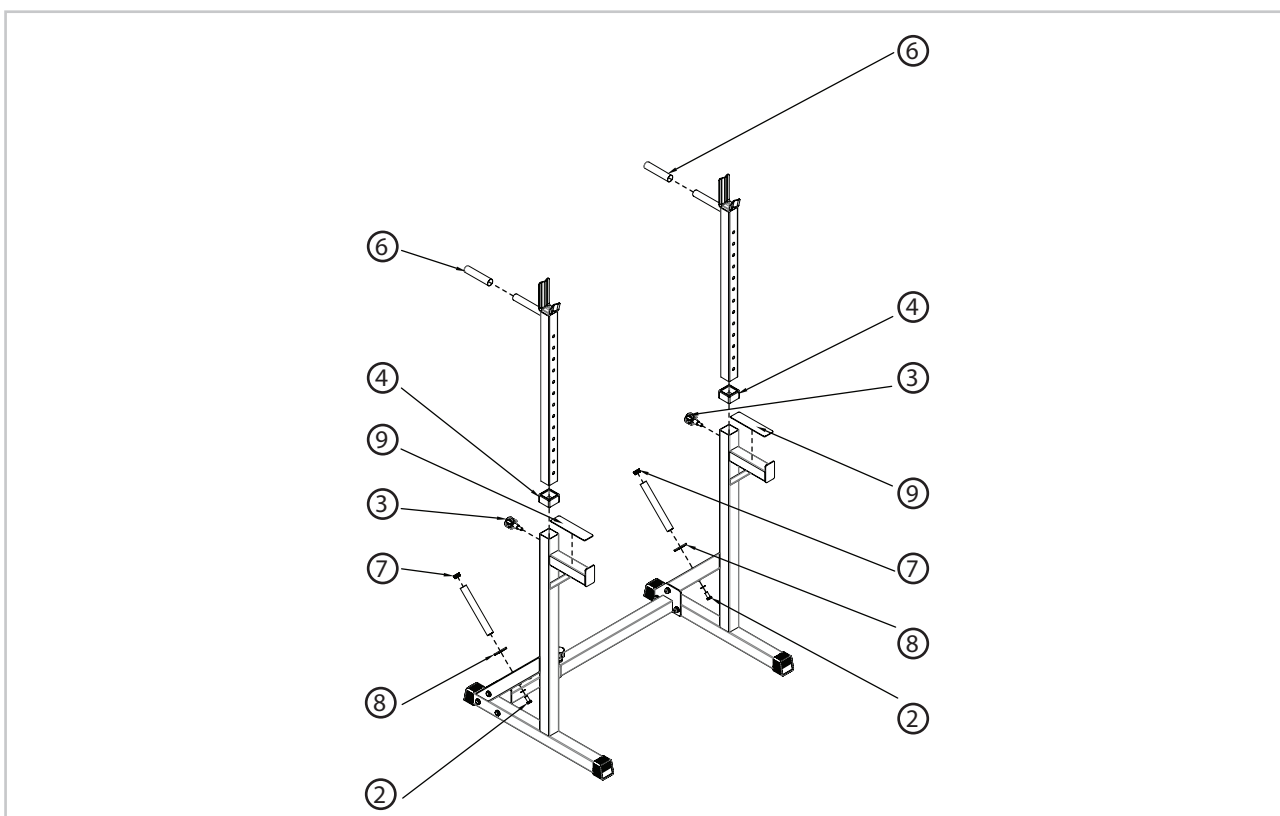

virtuafit

V případě dotazů nebo chybějících dílů kontaktujte svého prodejce.

Dovozce a distributor pro
Českou a Slovenskou republiku
Trinteco spol. s r.o.
Na Strži 2102/61a,
140 00 Praha 4 – Krč
IČ: 052 54 175
DIČ:CZ05254175



Dovozce a distributor pro Českou a Slovenskou republiku
Trinteco spol. s r.o.
Na Strži 2102/61a, 140 00 Praha 4 – Krč
IČ: 052 54 175 DIČ:CZ05254175

Email: info@trinteco.cz
Telefon: +420 725 552 257